

## Sliding Door

EN 13501-2 Classification  
EI<sub>2</sub>60

### Typology

Double leaf central  
closing with gate



Fire Test EN 1634-1

### CTE DB SI

According to the requirements established in the Basic Fire Safety Document of the Technical Building Code [CTE DB SI].

### Test Report

APPLUS 16/10460-205 P1 M1

### Extension Report

APPLUS 16/12230-1078 P1 M1

### Classification Report

APPLUS 16/12230-1078-2 P2 M1

CE MARKING

0370-CPR-3242

## ALFATORRES Metal double leaf sliding fire door with central closing CEI-60 model equipped with a passage gate.

Tested according to UNE-EN 1634-1 and classified as fire resistant EI<sub>2</sub>60 according to UNE EN 13501-2. The leaves consist of a system of our own panels, which are made of galvanized sheet metal. They are filled with rock wool and laminated calcium materials. The dedicated perimeter profile, which is made of galvanized steel that is 2 mm thick, makes the assembly very rigid.

Upper guides dimensioned according to the weight of the leaf. System of two double bearings to facilitate the continuous and smooth movement of the assembly. Lateral and upper overlaps made from galvanised sheet metal with intumescent sealing joint.

Central "U" receiver with intumescent system.

Passage gate made from 1.2 mm thick sheet metal with the same type of filling as the sliding leaf. It has a 3-point lock and a specific anti-panic bar and door-closing spring configuration. Lower crossbeam that is 40 mm high.

System of counterweights and internal cables, using pulleys located inside the sheet metal box at the same height as the leaf. It has an adjustable cover.

Standard activation with a fuse or an electromagnet (24v.)

Synchronisation of 1 leaf with the other depending on the use. When 1 leaf is moved, the other leaf moves at the same time.

### Optional dual-actuator system:

1. Commercial mode: the door is always held, usually in the open position. Allows synchronisation and uneven leaves.
2. Continuous mode: manual opening and closing of the door is allowed, without the need for activation by a fire signal. When a fire signal is sent, the door closes, regardless of the position it is in at the time. Allows for uneven leaves.

### POSSIBLE CONFIGURATIONS

- Motorised activation.
- Automatic or manual electrical reset
- Different configurations of weight placement.
- Speed regulators for controlled closing.
- Manufactured in sections to facilitate installation.
- Various guide supports for adaptation to suit the construction.
- Synchronised option (Check).
- Uneven leaves (Check).

Fire Door Product  
Technical Data

## Sliding Door

EN 13501-2 Classification  
EI<sub>2</sub>60

### Typology

Double leaf central  
closing with gate.

## Layout sketch for single leaf sliding doors

	Space Required 1 (mm.)	X (mm)	Y (mm)	H (mm)	W (mm)	Z (mm)
<b>Opposite Weight</b>	Portal Width/2 + 455	280	275	>310	290	-----
<b>Motorised</b>	Portal Width/2 + 540*	280	-----	>310*	290*	-----

\*Option of placing the motor in different positions, thus varying the following dimensions: EN, H and W

EN2 = EN1 - 165 mm.  
EN3 = EN1 - 240 mm.

### Counterbalanced opposite weight solution (1 counterweight only):

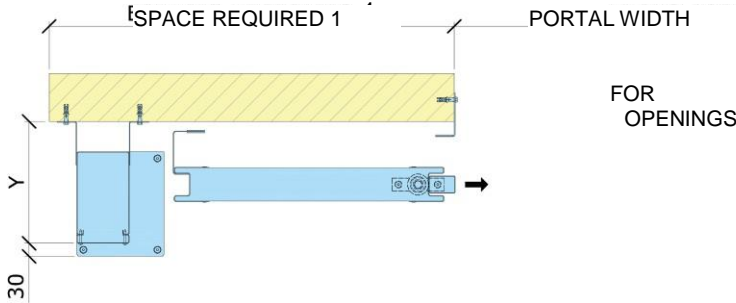

### SPACE REQUIRED 2

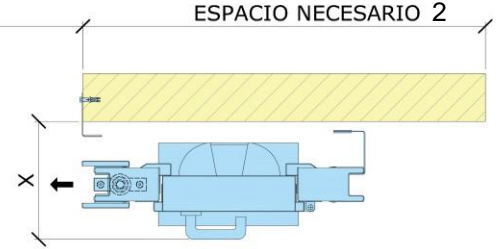

### Counterbalanced opposite weight solution (2 counterweights only):

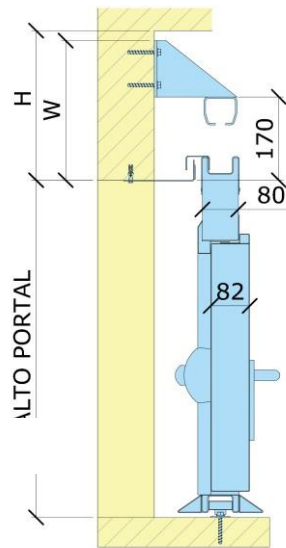
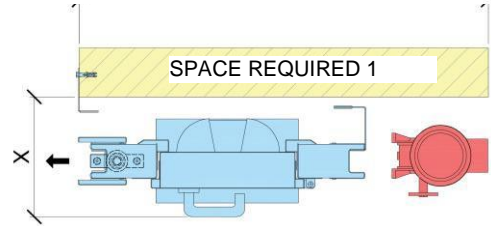
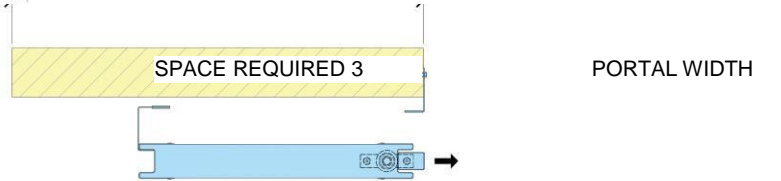
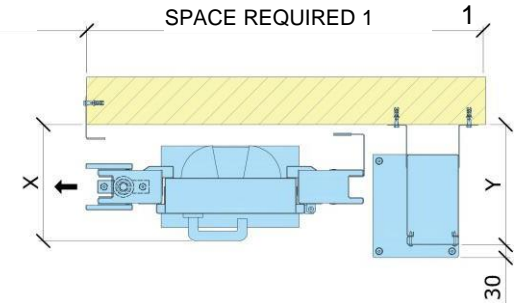
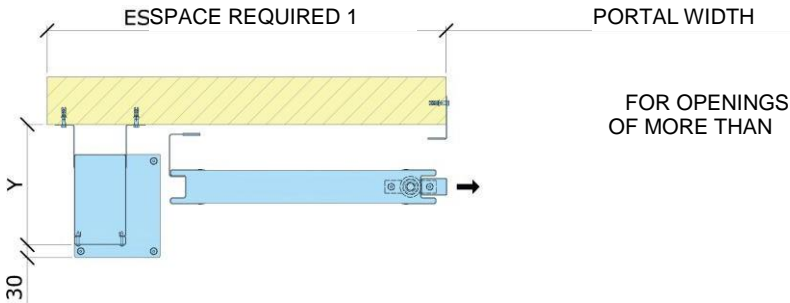

### Opening directions:

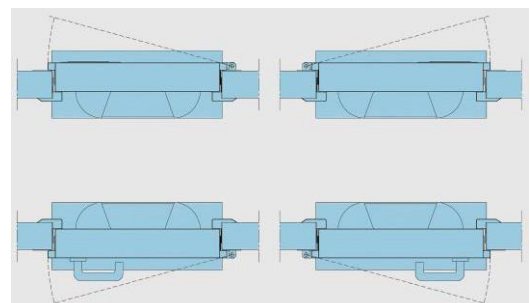

FD Data Sheet